

Wireless Bipolar Power Transistor, 2W

1.6 - 1.7 GHz

PH1617-2

V2.00

Features

- Designed for Linear Amplifier Applications
- Class AB: -33 dBc Typ 3rd IMD at 2 Watts PEP
- Class A: +44 dBm Typ 3rd Order Intercept Point
- Common Emitter Configuration
- Internal Input Impedance Matching
- Diffused Emitter Ballasting

Absolute Maximum Ratings at 25°C

Parameter	Symbol	Rating	Units
Collector-Base Voltage	V_{CBO}	65	V
Collector-Emitter Voltage	V_{CES}	65	V
Emitter-Base Voltage	V_{EBO}	3.0	V
Collector Current	I_C	2.0	A
Power Dissipation	P_D	13.5	W
Junction Temperature	T_J	200	°C
Storage Temperature	T_{STG}	-55 to +150	°C
Thermal Resistance	θ_{JC}	13	°C/W

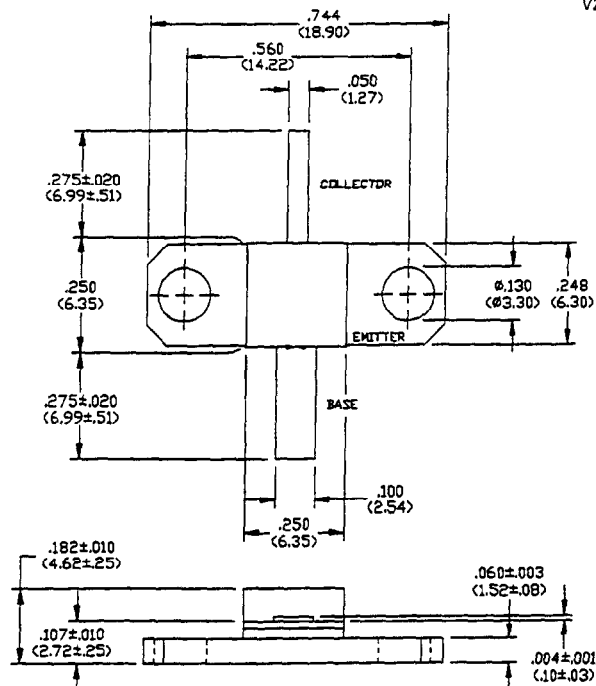

UNLESS OTHERWISE NOTED, TOLERANCES ARE INCHES ±.005" (MILLIMETERS ±.13MM)

Electrical Characteristics at 25°C

Parameter	Symbol	Min	Max	Units	Test Conditions
Collector-Emitter Breakdown Voltage	BV_{CES}	65	-	V	$I_C=5\text{ mA}$
Collector-Emitter Leakage Current	I_{CES}	-	1.0	mA	$V_{CE}=25\text{ V}$
Collector-Emitter Breakdown Voltage	BV_{CEC}	22	-	V	$I_C=5\text{ mA}$
Collector-Emitter Breakdown Voltage	BV_{CER}	30	-	V	$I_C=5\text{ mA}, R_{BE}=220\ \Omega$
Emitter-Base Breakdown Voltage	BV_{EBO}	3.0	-	V	$I_B=5\text{ mA}$
DC Forward Current Gain	h_{FE}	15	120	-	$V_{CE}=5\text{ V}, I_C=200\text{ mA}$
Power Gain	G_P	10	-	dB	$V_{CC}=25\text{ V}, I_{CC}=25\text{ mA}, P_{OUT}=2.0\text{ W}, F=1.60, 1.65, 1.70\text{ GHz}$
Collector Efficiency	η_C	35	-	%	$V_{CC}=25\text{ V}, I_{CC}=25\text{ mA}, P_{OUT}=2.0\text{ W}, F=1.60, 1.65, 1.70\text{ GHz}$
Input Return Loss	RL	10	-	dB	$V_{CC}=25\text{ V}, I_{CC}=25\text{ mA}, P_{OUT}=2.0\text{ W}, F=1.60, 1.65, 1.70\text{ GHz}$
Load Mismatch Tolerance	VSWR-T	-	5:1	-	$V_{CC}=25\text{ V}, I_{CC}=25\text{ mA}, P_{OUT}=2.0\text{ W}, F=1.60, 1.65, 1.70\text{ GHz}$
3rd Order IMD	IMD_3	-	-32	dBc	$V_{CC}=25\text{ V}, I_{CC}=25\text{ mA}, P_{OUT}=2.0\text{ W}, \text{PEP } F=1650\text{ MHz}, \Delta F=100\text{ KHz}$

Typical Optimum Device Impedances

F(GHz)	$Z_{IN}(\Omega)$	$Z_{LOAD}(\Omega)$
1.60	$3.5 + j8.2$	$6.6 + j13.5$
1.65	$3.9 + j8.5$	$6.4 + j13.1$
1.70	$4.2 + j8.7$	$6.3 + j12.8$

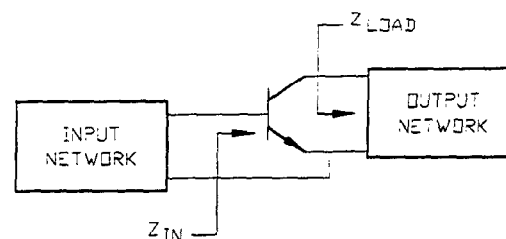

RF Test Fixture

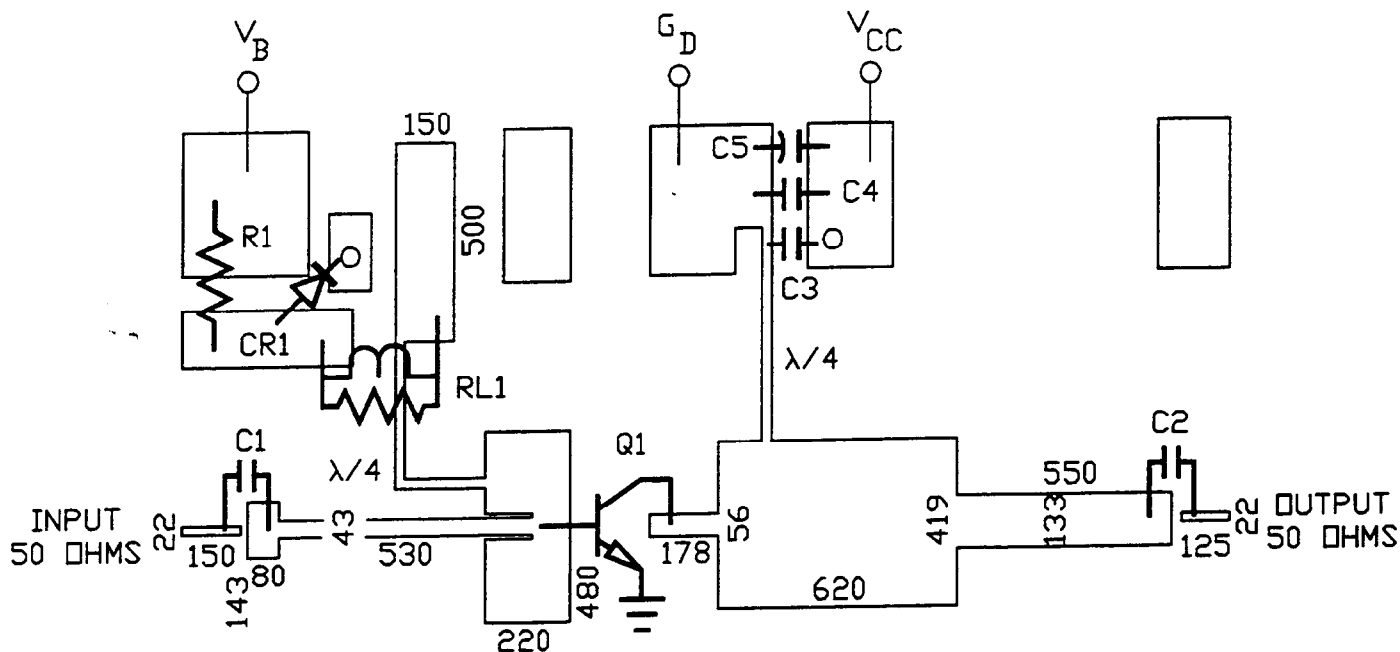

ARTWORK DIMENSIONS IN MILS

PARTS LIST

C1	C2	C3	33 pF	ATC	SIZE A
C4			4.7 uF	35 VOLTS	CHIP
C5			50 uF	50 VOLTS	
CR1			1N914B	DIODE	
Q1			PH1617-2		
R1			5Ω	1/4 WATT	
RL1			6T/NO.	24 AWG DN 3Ω 1/4WATT	
BOARD TYPE: ROGERS 6010.5 25 MILS THICK, $E_R = 10.5$					

Typical Broadband Performance Curves

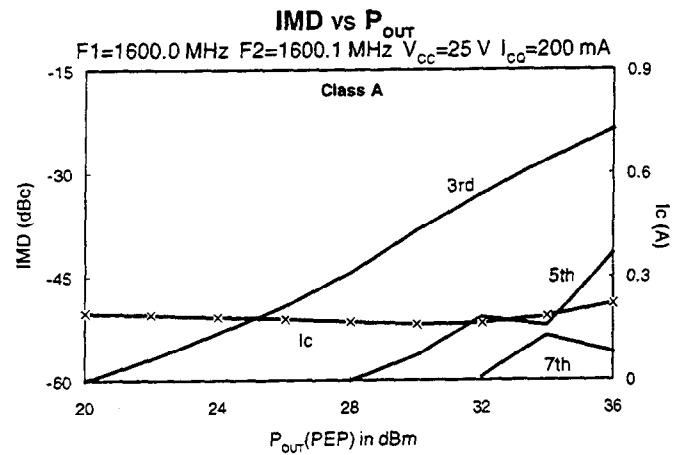
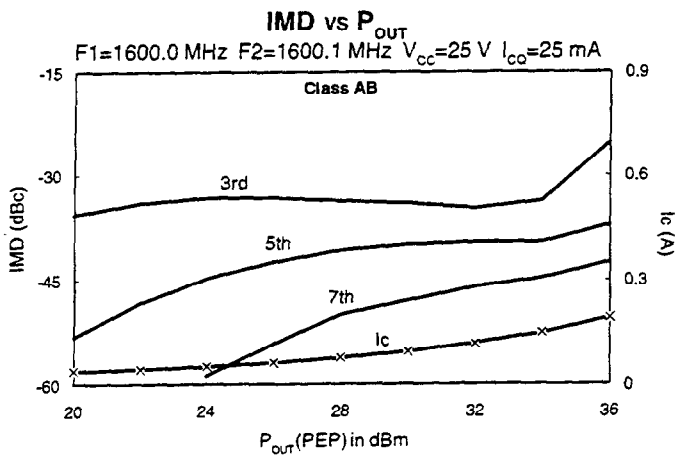
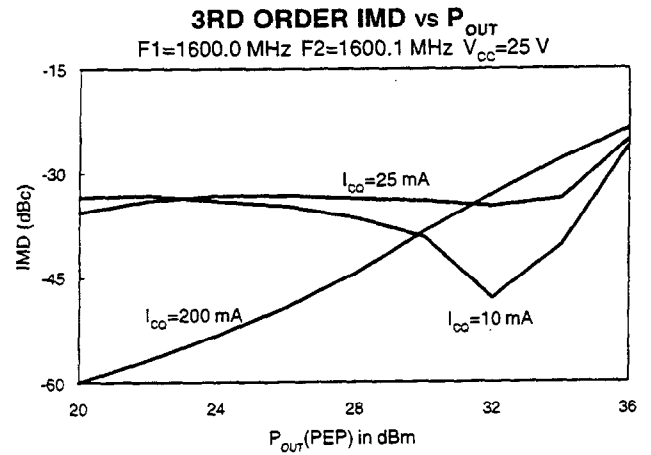
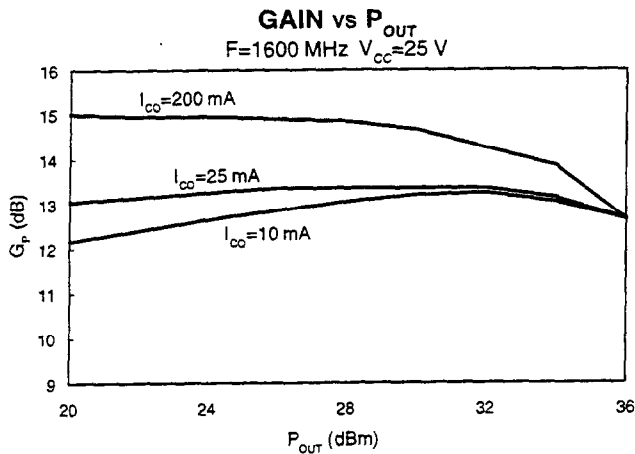
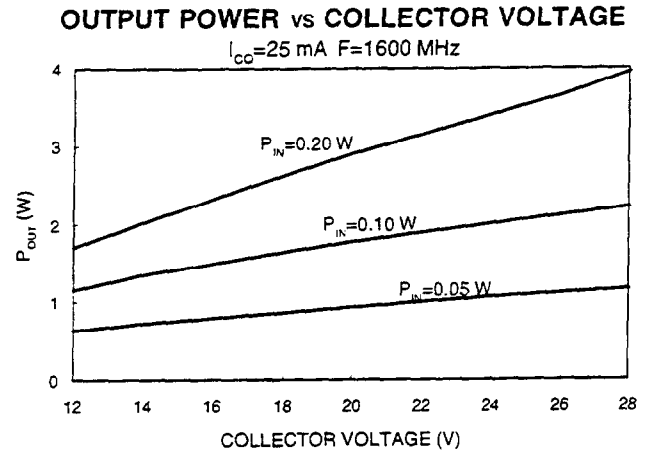
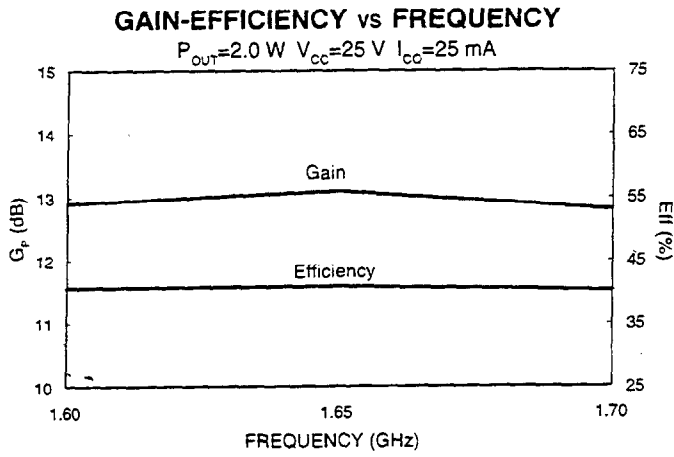

Typical S-Parameters

 $V_{CC}=25\text{ V}$, $I_{CO}=200\text{ mA}$

f(MHz)	S11		S21		S12		S22	
	Mag	Phase	Mag	Phase	Mag	Phase	Mag	Phase
100	1.10	171.5	23.80	120.3	0.012	-7.4	0.32	-74.5
200	0.75	175.1	12.15	92.1	0.014	-4.7	0.22	-89.6
300	0.79	-177.9	7.79	81.2	0.016	-4.5	0.20	-95.7
400	0.84	-177.4	5.77	74.4	0.016	-9.8	0.23	-98.7
500	0.87	-178.5	4.65	68.4	0.017	-3.7	0.26	-100.5
600	0.89	179.8	3.96	62.6	0.018	-5.9	0.27	-101.4
700	0.89	178.3	3.49	56.7	0.018	-0.7	0.29	-104.4
800	0.91	177.4	3.08	51.1	0.019	-2.7	0.33	-103.3
900	0.91	175.4	2.89	45.4	0.017	-3.4	0.36	-111.0
1000	0.91	174.1	2.74	38.9	0.019	-0.9	0.40	-114.6
1100	0.89	171.5	2.64	28.9	0.024	-6.1	0.46	-117.3
1200	0.87	171.7	2.45	22.8	0.024	-13.6	0.53	-120.8
1300	0.86	170.8	2.35	15.7	0.023	-18.3	0.57	-122.3
1400	0.86	170.3	2.32	7.6	0.026	-21.1	0.63	-145.5
1450	0.85	170.1	2.30	3.4	0.026	-22.9	0.65	-126.2
1500	0.84	169.9	2.27	-1.2	0.025	-22.3	0.66	-127.6
1550	0.83	169.7	2.26	-6.4	0.026	-31.0	0.68	-129.1
1600	0.82	169.7	2.24	-11.5	0.030	-37.3	0.71	-131.9
1650	0.82	170.0	2.22	-16.6	0.029	-43.2	0.72	-133.6
1700	0.81	170.5	2.19	-22.4	0.027	-48.5	0.73	-137.6
1750	0.80	171.1	2.14	-28.4	0.025	-52.2	0.76	-140.1
1800	0.80	171.5	2.11	-35.5	0.026	-60.2	0.76	-143.9
1850	0.80	171.9	2.05	-40.7	0.027	-60.1	0.81	-147.5
1900	0.81	172.6	1.99	-47.4	0.024	-67.1	0.81	-150.1
2000	0.82	173.6	1.83	-60.7	0.024	-80.8	0.86	-155.5
2100	0.84	174.5	1.61	-74.0	0.020	-94.0	0.88	-160.0
2200	0.88	174.2	1.40	-84.6	0.019	-104.7	0.87	-164.5
2300	0.90	173.6	1.21	-94.7	0.016	-128.7	0.86	-168.1